

KL406A, KL425A, KL440A, KL460A

DIP4 FORM A SSR

DIP4 FORM A 固态继电器

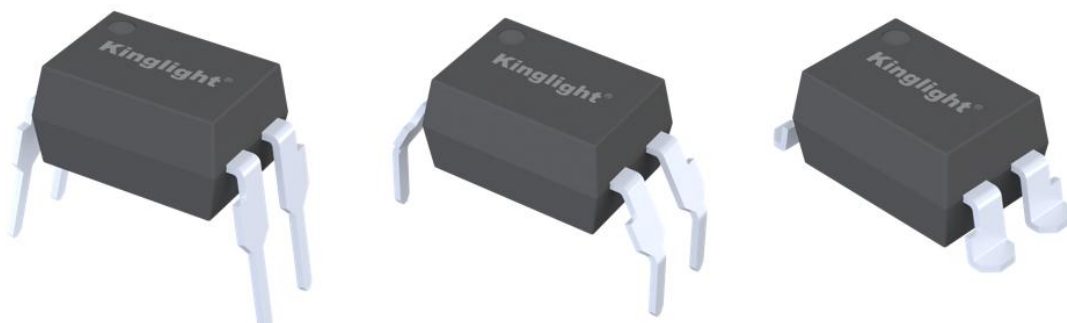

* 本文件中包含的信息反映了具有代表性的使用场景，仅供技术参考。

The information contained in this document reflects representative usage scenarios and is intended for technical reference only.

* 本文件中提到的产品型号和规格如有更改或改进，恕不另行通知。在生产使用之前，客户应参考产品规格书的最新数据表。

Product models and specifications mentioned in this document are subject to change or improvement without notice. Customers should refer to the latest data sheets in the product specifications prior to production use.

* 在使用本文件中引用的产品时，请确保产品在数据手册中规定的环境和电气限制范围内运行。如果客户使用超过指定的限制，晶台将不会对任何后续问题负责。

When using the products referenced in this document, ensure that the products are operated within the environmental and electrical limits specified in the data sheet. If the customer uses the product beyond the specified limits, Kinglight will not be responsible for any subsequent problems.

* 本文件中的信息适用于电子元器件应用中的典型用法。如有任何特殊用途，请向晶台咨询，以获得进一步的帮助。

The information in this document applies to typical use in electronic component applications. For special applications, please contact Kinglight for further assistance.

* 未经晶台允许，不得复制或转载本文件的内容和信息。对于最新的信息，请参考官方网站 [Http:// www.kinglight-semi.com](http://www.kinglight-semi.com)。

The contents and information in this document may not be copied or reproduced without the permission of Kinglight. For the latest information, please visit the official website [Http:// www.kinglight-semi.com](http://www.kinglight-semi.com).

1. 产品特点 Product features

- 常开信号极单掷继电器 Normally open signal pole single throw relay
- 低工作电流 Low operating current
- 60 至 600V 输出耐压 60 to 600V output withstand voltage
- 低电阻 Low on resistance
- 宽工作温度范围(-40°C 至 85°C) Wide operating temperature range of -40°C to 85°C
- 无卤素 (溴<900ppm, 氯<900ppm, 溴+氯<1500ppm)
Halogens free (Br < 900ppm, Cl < 900ppm, Br+Cl < 1500ppm)
- 输入与输出间高隔离电压(Viso=5000 V rms)
High isolation voltage between inputs and output (Viso=5000 V rms)
- 符合欧盟REACH法规 Compliance with EU REACH
- 无Pb且符合ROHS标准 Pb free and RoHS compliant

2. 产品描述 Product Description

- KL406A、KL425A、KL440A 和 KL460A 是固态继电器，它们在发光侧（输入侧）装有一个 AlGaAs 红外LED，该 LED 与一个高压输出检测器电路光学耦合。这个检测器由一个光电二极管阵列和输出侧的金属-氧化物半导体场效应晶体管组成。单通道配置相当于 1 个form A电磁继电器。
The KL406A, KL425A, KL440A and KL460A are solid state relays containing an AlGaAs infrared LEDs on the light emitting side (input side) optically coupled to a high voltage output detector circuit. The detector consists of a photovoltaic diode array and MOSFETs on the output side. The single channel configuration is equivalent to 1 form A EMR.
- 它们采用 4 引脚 DIP 封装，并提供宽引线间距和 SMD 选择。
They are packaged in 4 pin DIP and available in surface mount SMD option.

3. 产品应用 Product Applications

- 交换设备 Exchange equipment
- 测量设备 Measurement equipment
- 工厂自动化/办公自动化设备 FA/OA equipment
- 工业控制，安全 Industrial controls, Security

4. 功能图 Functional Diagram

Schematic

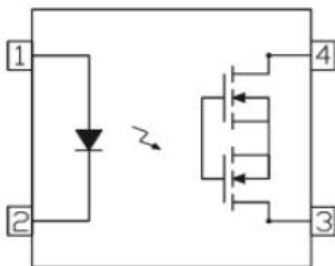

引脚配置 Pin Configuration

1. LED阳极 LED Anode
2. LED阴极 LED Cathode
- 3,4. 金属-氧化物半导体场效应晶体管 MOSFET

5. 光电特性 Electrical-Optical characteristics

• 最大限度额定值(温度=25°C) Absolute Maximum Ratings($T_A=25^\circ\text{C}$)

参数 Parameter		符号 Symbol	额定值 Rated Value				单位 Unit
			KL406A	KL425A	KL440A	KL460A	
输入 Input	正向电流 Forward current	I_F	50				mA
	反向电压 Reverse voltage	V_R	5				V
	峰值正向电流 (1*) Peak Forward Current	I_{FP}	1				A
	功耗 Power dissipation ($T_A = 25^\circ\text{C}$)	P_{IN}	75				mW
输出 Output	击穿电压 (2*) Break Down Voltage	V_L	60	250	400	600	V
	持续负载电流 Continuous Load Current	I_L	550	150	120	50	mA
	脉冲负载电流 (3*) Pulse Load Current	I_{Lpeak}	1.2	0.5	0.3	0.15	A
	功耗 Power Dissipation	P_{Out}	500				mW
总功耗 Total Power Dissipation		P_T	550				mW
隔离电压 (4*) Isolation Voltage		V_{iso}	5000				V rms
工作温度 Operating temperature		T_{OPR}	-40 to +85				$^\circ\text{C}$
储存温度 Storage temperature		T_{STG}	-40 to +125				$^\circ\text{C}$
焊接温度 (5*) Soldering temperature		T_{SOL}	260				$^\circ\text{C}$

附注 (Notes):

1* $f=100\text{Hz}$, 占空比 = 0.1% $f=100\text{Hz}$, Duty Cycle = 0.1%

2* 直流和交流峰值 Indicate the DC and peak AC values

3* A 连通: 100 ms (1 次), V_L = 直流或交流峰值 A connection: 100 ms (1 shot), V_L = DC or peak AC

4* 交流电源1分钟内, 相对湿度在40~60%RH环境下, 隔离电压测试时, 1&2脚短接在一起, 3&4脚短接在一起

AC for 1 minute, R.H.= 40 ~ 60% R.H. In this test, pins 1&2 are shorted together, and pins 3,&4 are shorted together.

5* 焊接时间为10秒 Soldering time is 10 seconds

6. 电气特性(Ta=25°C,除非另有规定)

Electrical Characteristics(Ta=25°C unless specified otherwise)

参数 Parameter		符号 Symbol	最小值 Min.	规格值 Typ.	最大值 Max.	单位 Unit	条件 Condition	
输入 In put	正向电压 Forward voltage	V_F	-	1.18	1.5	V	$I_F=10\text{mA}$	
	反向电流 Reverse current	I_R	-	-	1	uA	$V_R=5\text{V}$	
输出 Out put	关闭状态泄漏电流 Off State leakage Current		I_{leak}	-	-	1	uA	$I_F = 0\text{mA},$ $V_L = \text{Max}$
	导通电阻 On Resistance	KL406A	$R_{d(\text{ON})}$	-	0.7	2.5	Ω	$I_F = 10\text{mA},$ $I_L = \text{Max.}$ $t = 1\text{s}$
		KL425A		-	6.5	15		
		KL440A		-	20	30		
		KL460A		-	40	70		
	输出电容 Out put Capacitance	KL406A	C_{out}	-	85	-	pF	$V_L = 0\text{V},$ $f = 1\text{MHz}$
		KL425A		-	60	-		
		KL440A		-	45	-		
KL460A		-		30	-			

• 传输特性

Transfer Characteristics

参数 Parameter		符号 Symbol	最小值 Min.	规格值 Typ.*	最大值 Max.	单位 Unit	条件 Condition
LED 打开电流 LED turn on Current	KL406A	$I_{F(on)}$	-	3	5	mA	$I_L = \text{Max.}$
	KL425A						
	KL440A						
	KL460A						
LED 关闭电流 LED turn off Current	KL406A	$I_{F(off)}$	0.4	3	-	mA	$I_L = \text{Max.}$
	KL425A						
	KL440A						
	KL460A						
打开时间 Turn On Time	KL406A	T_{on}	-	1.4	3	ms	$I_F = 10 \text{ mA,}$ $I_L = \text{Max.}$ $R_L = 200\Omega ,$
	KL425A						
	KL440A						
	KL460A						
关闭时间 Turn Off Time	KL406A	T_{off}	-	0.05	0.5	ms	
	KL425A						
	KL440A						
	KL460A						
隔离电阻 Isolation Resistance		R_{I-O}	5×10^{10}	-	-	Ω	$V_{I-O} = 500V \text{ DC}$
隔离电容 Isolation Capacitance		C_{I-O}	-	1.5	-	pF	$V = 0V,$ $f = 1MHz$

7. 特性曲线 Characteristic Curves

图1-1. 负载电流 vs 环境温度的关系

Figure 1-1. Load Current vs Ambient Temperature



图1-2. 负载电流 vs 环境温度的关系

Figure 1-2. Load Current vs Ambient Temperature

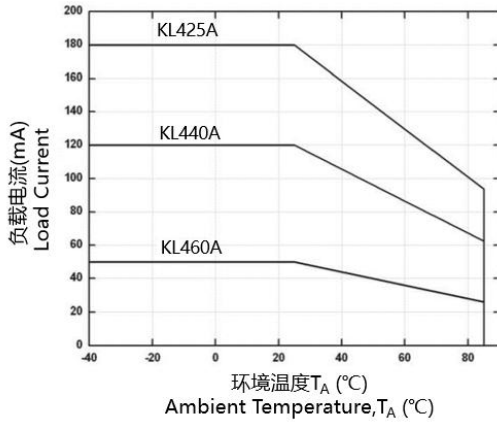

图2-1. 导通电阻 vs 环境温度的关系

Figure 2-1. On Resistance vs Ambient Temperature

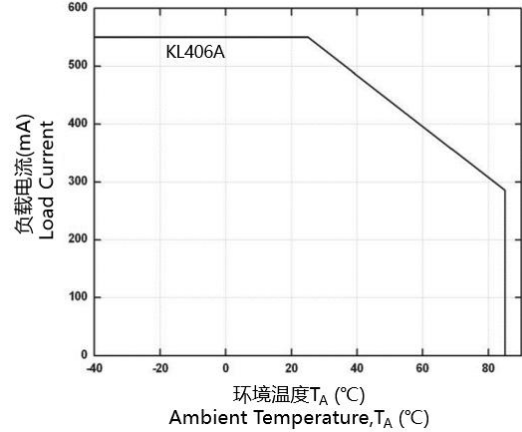

图2-2. 导通电阻 vs 环境温度的关系

Figure 2-2. On Resistance vs Ambient Temperature

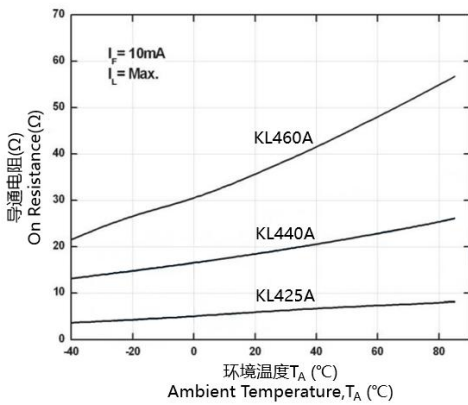

图3. 响应时间 vs 环境温度的关系

Figure 3. Switching Time vs Ambient Temperature

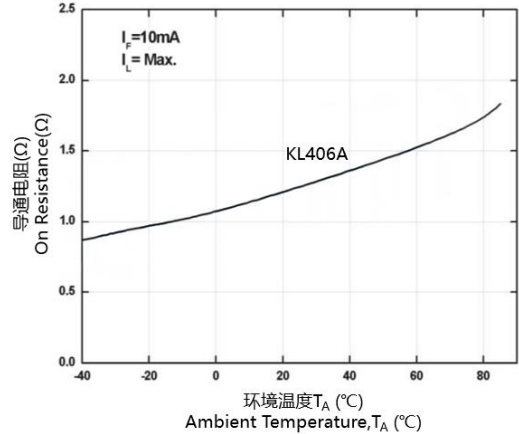

图4-1. 开启时间 vs LED正向电流的关系

Figure 4-1. Turn-on Time vs LED Forward Current

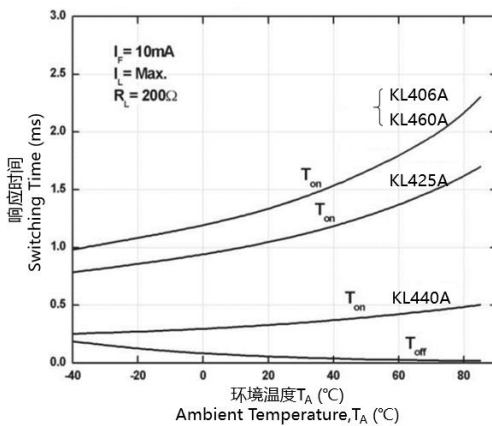

图4-2. 开启时间 vs LED正向电流的关系

Figure 4-2. Turn-on Time vs LED Forward Current

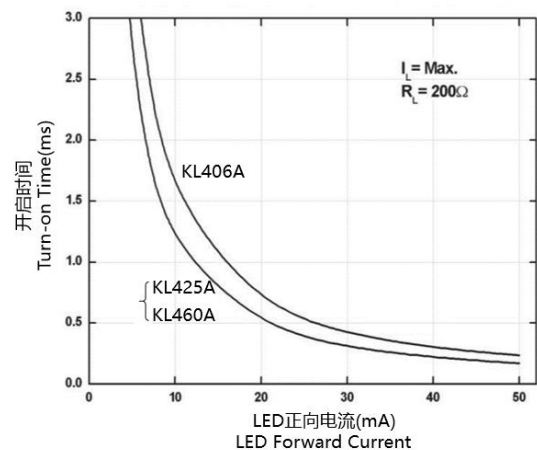

图6. LED工作电流 vs 环境温度的关系

Figure 6. LED operate on Current vs Ambient Temperature

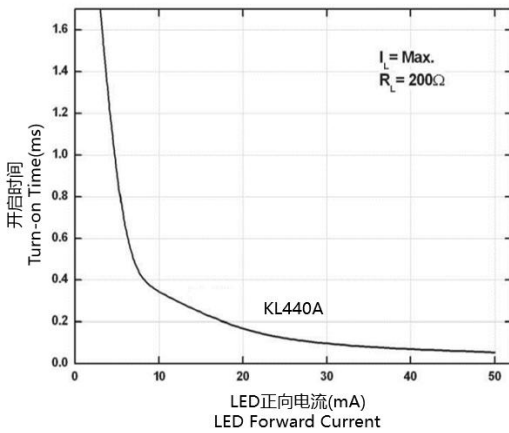

图8. LED下降电压 vs 环境温度的关系

Figure 8. LED Dropout Voltage vs Ambient Temperature

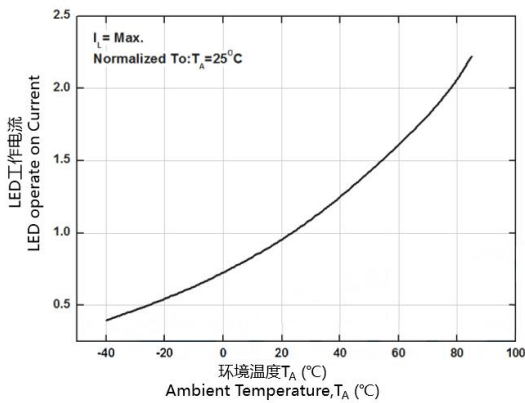

图5. 关闭时间 vs LED正向电流的关系

Figure 5 Turn-off Time vs LED Forward Current

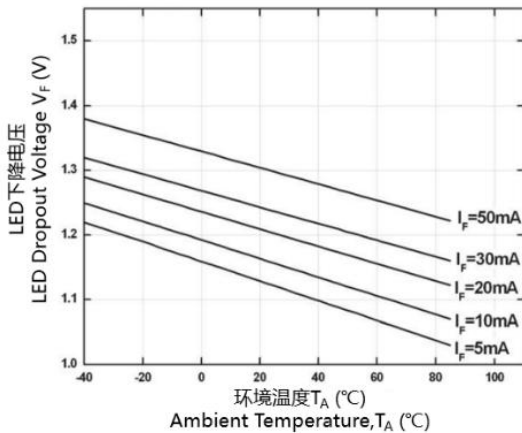

图7. LED关闭电流 vs 环境温度的关系

Figure 7 LED turn off Current vs Ambient Temperature

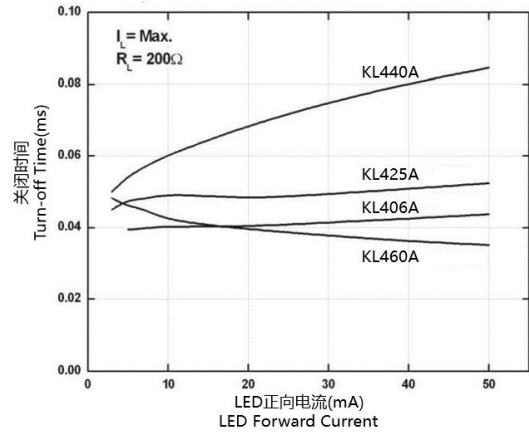

图9-1. 负载电流 vs 负载电压的关系

Figure 9-1 Load Current vs Load Voltage

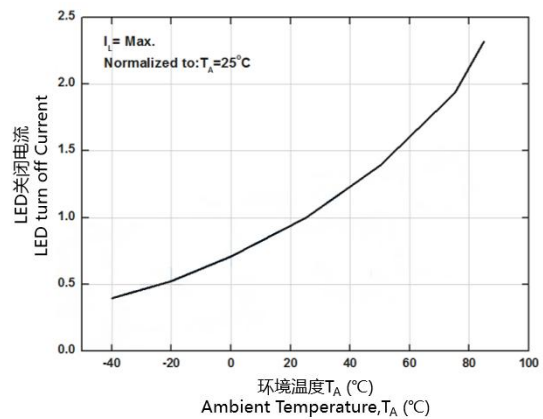

图9-2. 负载电流 vs 负载电压的关系

图10. 断态漏电流 vs 负载电压的关系

Figure 9-2. Load Current vs Load Voltage

Figure 10 Off State Leakage Current vs Load Voltage

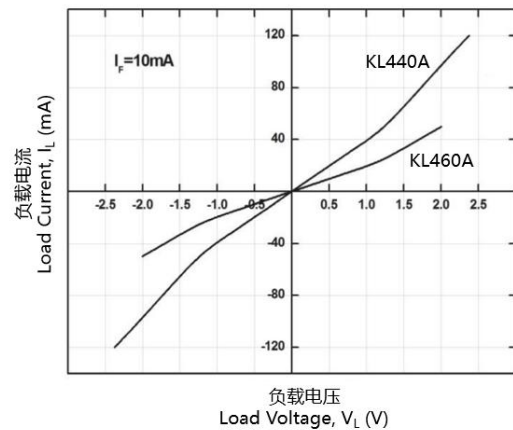

图11. 输出电容 vs 施加电压

Figure 11. Output Capacitance vs Applied Voltage

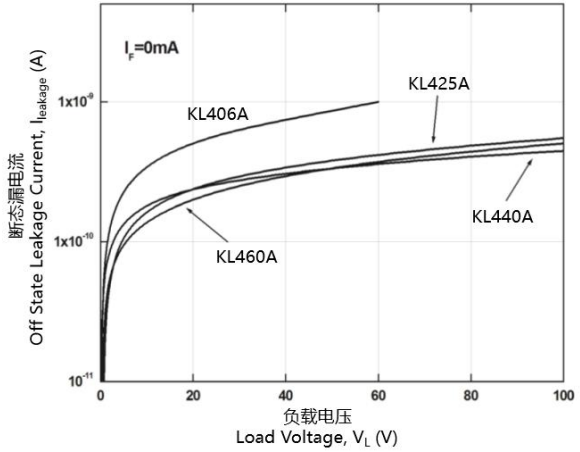
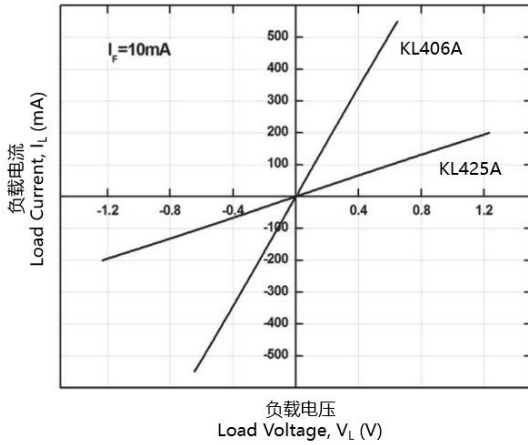
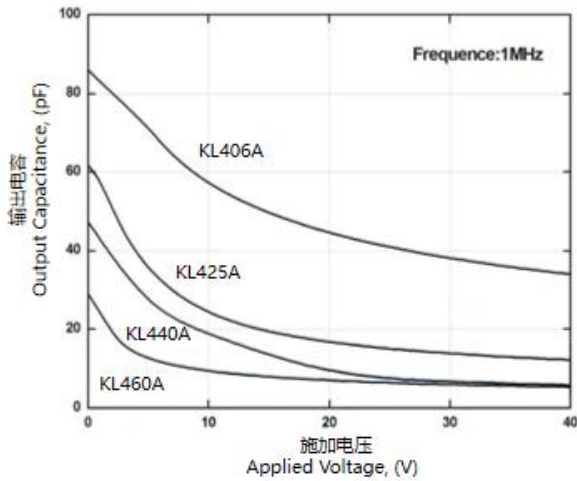

8. 订单信息 Order Information

- 材料编号 Part Number

KL4XXAY-Z-V

附注(Notes):

XX =零件编号(06、25、40或60) Part No. (06, 25, 40 or 60)

Y = 引脚形式选项(S1、M或无)

Lead form option (S1, M or none)

Z = 料带和卷轴选项(TA、TB、TU、TD or none)

Tape and reel option (TA, TB, TU, TD或无)

V = 表示VDE标识(客户指定镭射字符才加"V")

VDE (Only add "V" to laser characters specified by the customer)

选项 Option	描述 Description	包装数量 Packing quantity
无 None	标准 DIP-4 Standard DIP-4	每管100pcs 100 units per tube
M	宽引脚弯曲(0.4英寸间距) Wide lead bend (0.4 inch spacing)	每管100pcs 100 units per tube
S1-TA	表面贴装引线形式(低剖面)+TA载带和卷轴选项 Surface mount lead form (low profile) + TA tape & reel option	每卷1000pcs 1000 units per reel
S1-TB	表面贴装引线形式(低剖面)+TB载带和卷轴选项 Surface mount lead form (low profile) + TB tape & reel option	每卷1000pcs 1000 units per reel
S1-TU	表面贴装引线形式(低剖面)+TU载带和卷轴选项 Surface mount lead form (low profile) + TU tape & reel option	每卷1500pcs 1500 units per reel
S1-TD	表面贴装引线形式(低剖面)+TD载带和卷轴选项 Surface mount lead form (low profile) + TD tape & reel option	每卷1500pcs 1500 units per reel

9. 封装尺寸(单位:毫米) Package Drawing(Unit:mm)

- 标准DIP型号 Standard DIP Type

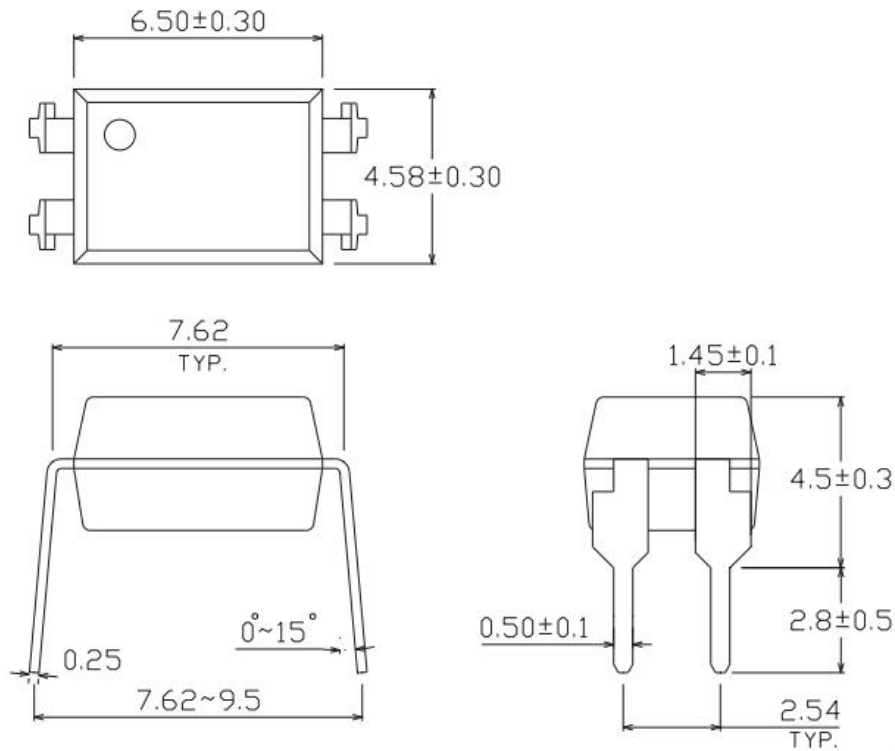

- 选择M型号 Option M Type

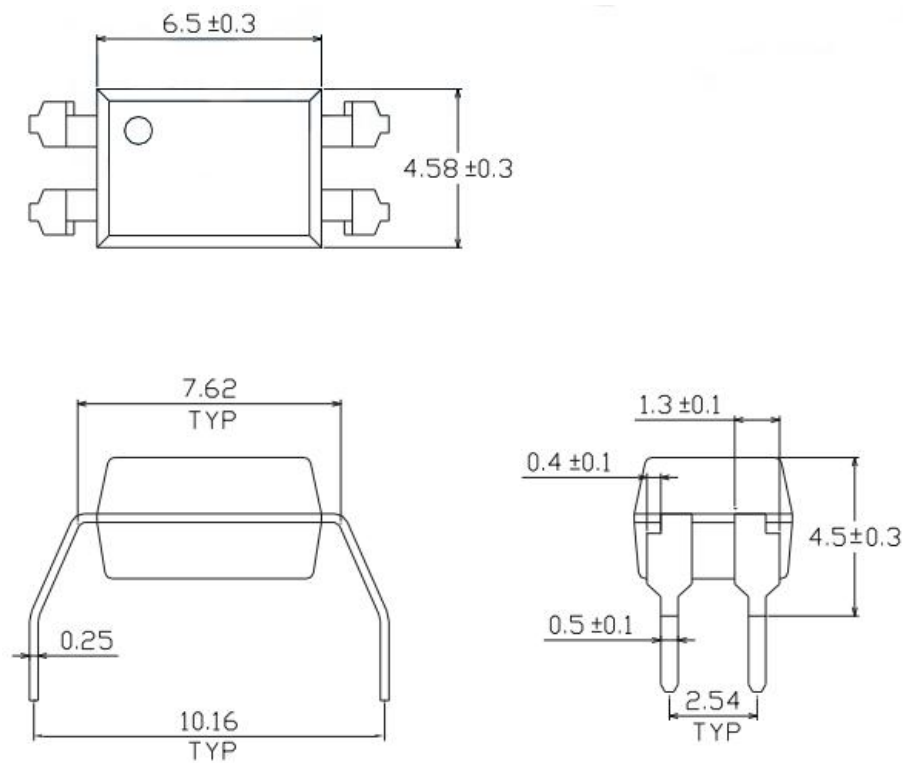

- 选择S1型号 Option S1 Type

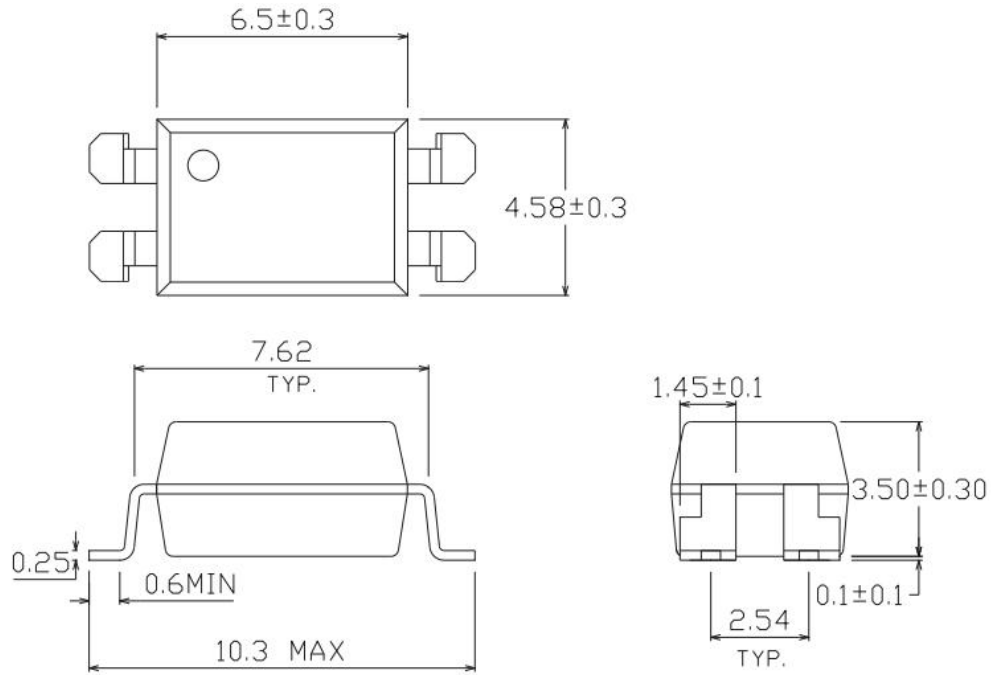

- 表面贴装引线框架 推荐焊盘布局 Recommended pad layout for surface mount leadform 4PIN SMD

S1选项 For S1 option

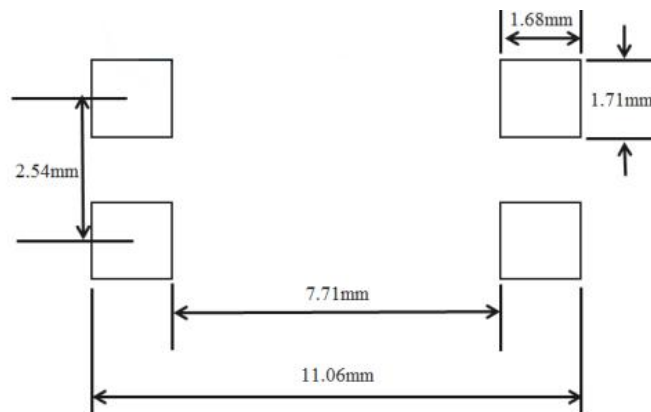

附注(Notes):

- 建议焊盘尺寸仅供参考 Suggested pad dimension is just for reference only
- 请根据个人需要修改焊盘尺寸 Please modify the pad dimension based on individual need

10.设备标记 Device marking

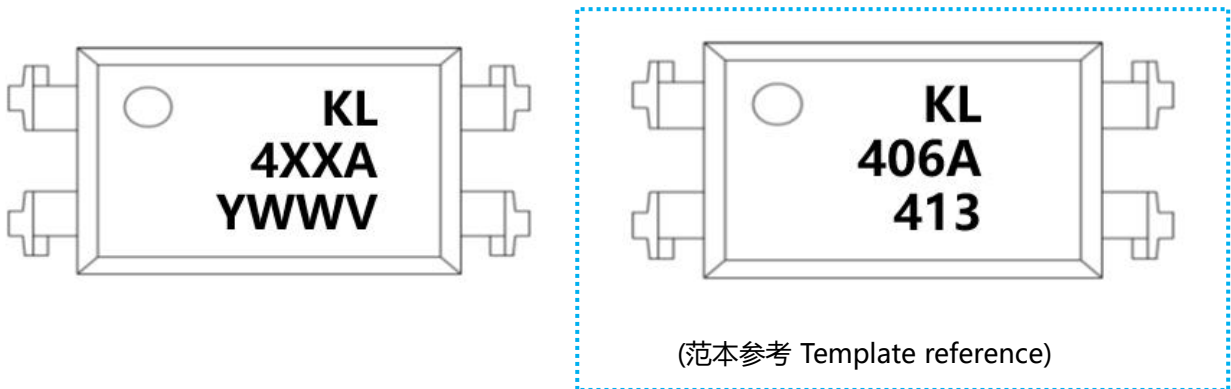

附注(Notes):

- KL = 表示晶台光电有限公司 Denotes KingLight
- 4XXA = 表示材料部件号 Denotes Device Part Number
XX表示零件编号(06、25、40或60) Part No. (06, 25, 40 or 60)
- Y = 表示1位年份代码Denotes 1 digit Year code
- WW = 表示2位周别代码Denotes 2 digit Week code
- V = 表示VDE标识(客户指定镭射字符才加"V")
VDE (Only add "V" to laser characters specified by the customer)

11.料带和卷轴包装规格 Tape & Reel Packing Specifications

• 选择TA Option TA

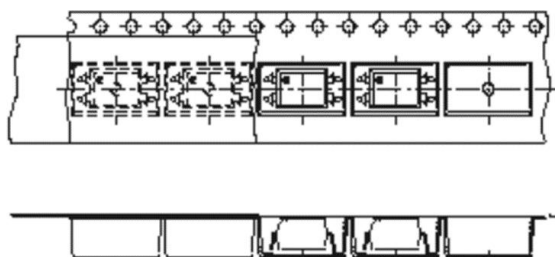

卷轴进给方向 Direction of feed from reel

• 选择TB Option TB

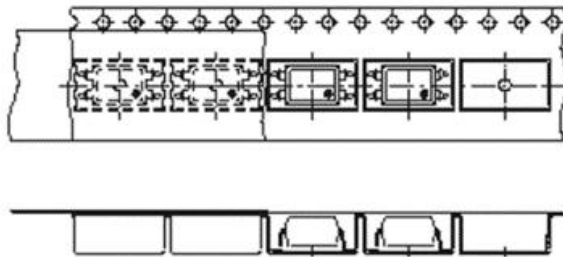

卷轴进给方向 Direction of feed from reel

料带尺寸 Material belt size

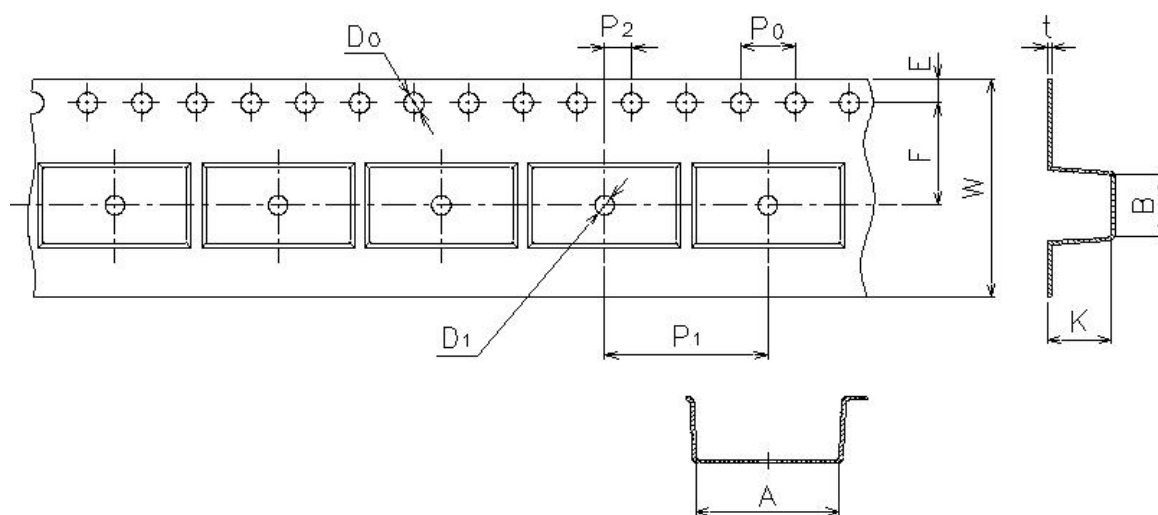

尺寸编号 Dimension No.	A	B	D0	D1	E	F
尺寸(mm) Dimension(mm) S1	10.7±0.1	4.65±0.1	1.5±0.1	1.50±0.1	1.75±0.1	7.5±0.1
尺寸编号 Dimension No.	P0	P1	P2	t	W	K
尺寸(mm) Dimension(mm) S1	4.0±0.1	12.0±0.1	2.0±0.1	0.4±0.1	16.0±0.3	3.9±0.1

• 选择TU Option TU

• 选择TD Option TD

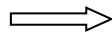
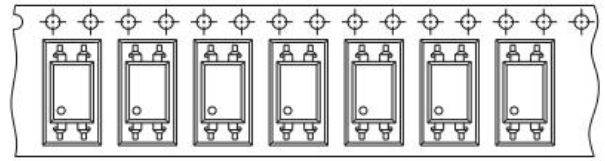
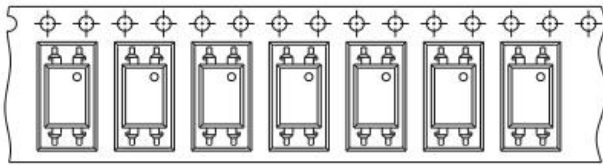

卷轴进给方向 Direction of feed from reel

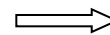

卷轴进给方向 Direction of feed from reel

料带尺寸Material belt size

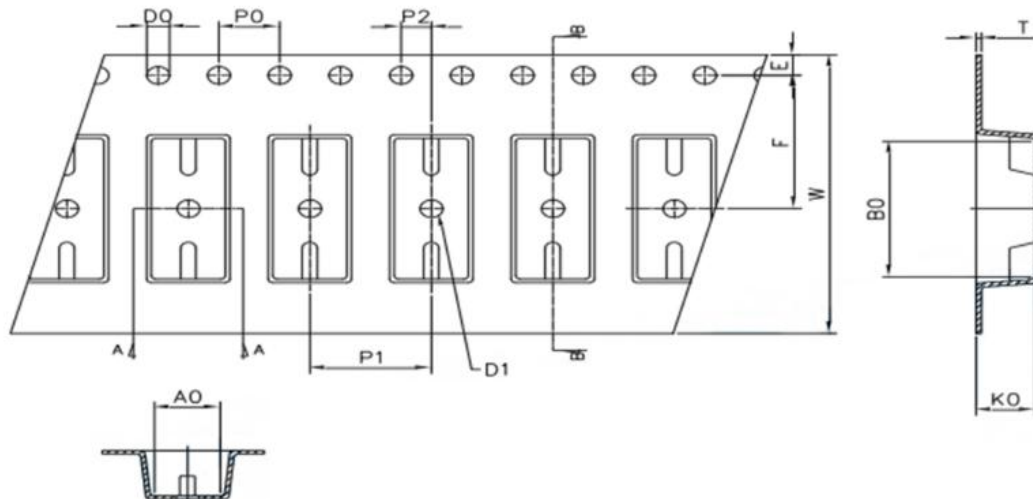

尺寸编号 Dimension No.	A0	B0	D0	D1	E	F
尺寸(mm) Dimension(mm) S1	4.9±0.1	10.4±0.1	1.5±0.1	1.5±0.1	1.75±0.1	7.5±0.1
尺寸编号 Dimension No.	P0	P1	P2	t	W	K
尺寸(mm) Dimension(mm) S1	4.0±0.1	8.0±0.1	2.0±0.1	0.4±0.1	16.0±0.3	4.6±0.1

12. 焊接温度曲线 Temperature Profile Of Soldering

• 回流焊温度曲线 Reflow soldering

建议在下面所示的温度和时间分布条件下, 进行一次回流焊作业, 不得超过三次

One time soldering reflow is recommended within the condition of temperature and time profile shown below. Do not solder more than three times.

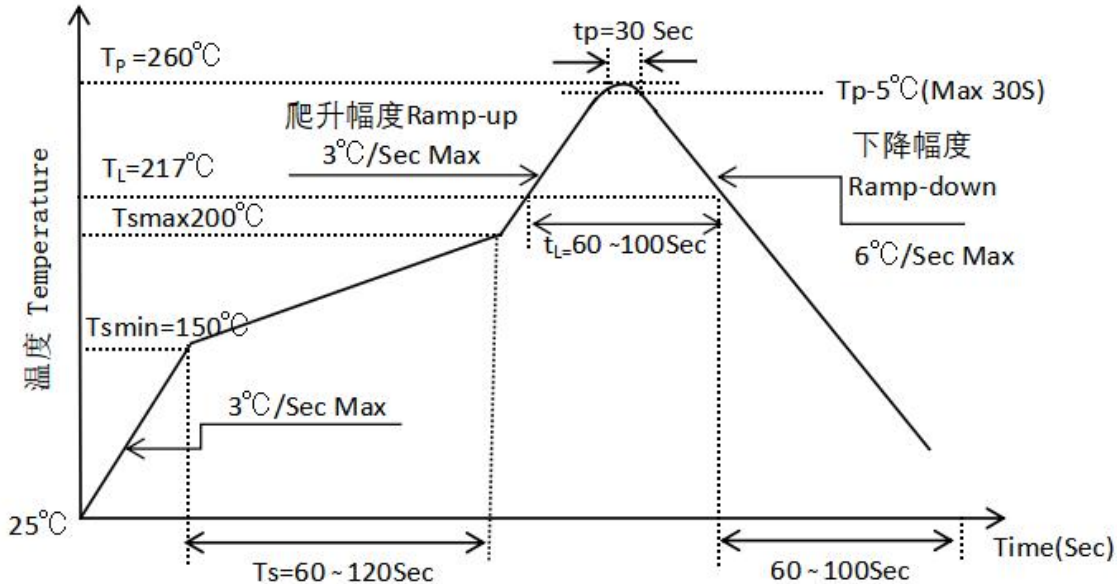

项目 Item	符号 Symbol	最小值 Min.	最大值 Max.	单位 Unit
预热温度 Preheat Temperature	T_s	150	200	°C
预热时间 Preheat Time	t_s	60	120	s
升温速率 Ramp-Up Rate (T_L to T_p)	-	-	3	°C/s
液相线温度 Liquidus Temperature	T_L	217		°C
高于液相线温度(T_L)的时间 Time above Liquidus Temperature T_L	t_L	60	100	s
峰值温度 Peak Temperature	T_p	-	260	°C
T_c 在(T_p-5)和 T_p 之间的时间 Time During Which T_c Is Between (T_p-5) and T_p	t_p	-	30	s
降温速率 Ramp-down Rate(T_p to T_L)	-	-	6	°C/s

• 波峰焊温度曲线 Wave Soldering

温度条件下, 建议一次焊接

One time soldering is recommended within the condition of temperature

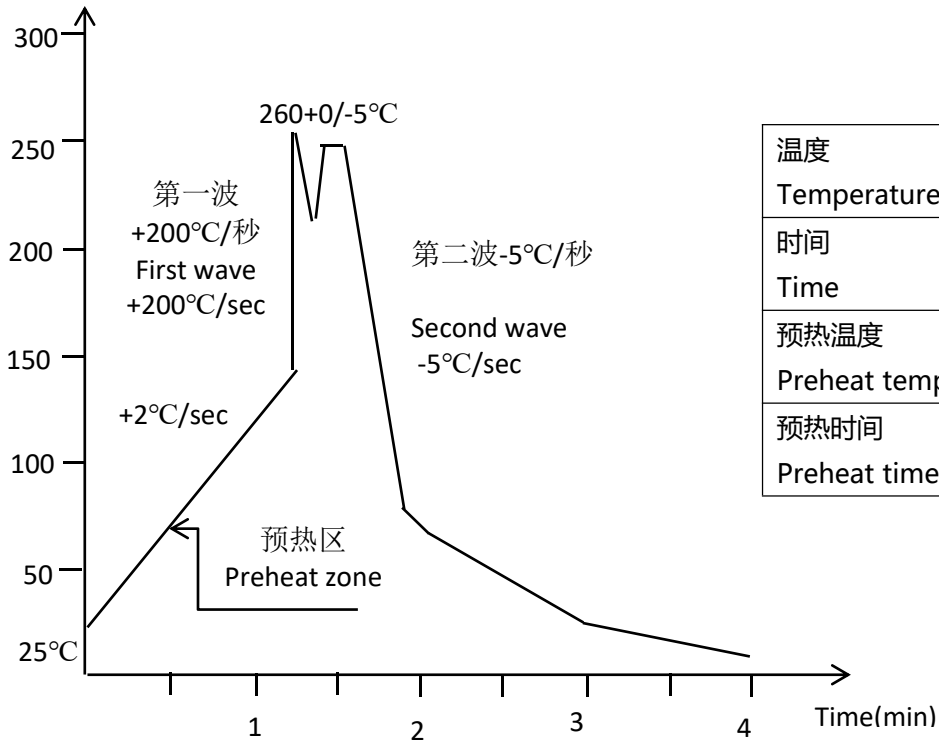

温度 Temperature	260°C+0/-5°C
时间 Time	10秒 10S
预热温度 Preheat temperature	25至140°C 25 to 140°C
预热时间 Preheat time	30至80秒 30 to 80 S